

# Cash Acme™ E3 Pressure Regulating Valve

The Cash Acme™ E3 Pressure Regulating Valve automatically reduces a high inlet pressure to a lower delivery pressure and maintains the lower pressure within acceptable limits. It provides substantially higher capacity and closer regulation for more demanding and higher quality installations. The E3 incorporates a yoke-type design, allowing the regulator to close against the inlet pressure and provide quieter operation under wide and varying flow conditions.

## Approved Applications

Commercial and residential water and dry, filtered air applications.

## Specification Data

Performance	
Maximum Inlet pressure	300 psi
Temperature range	33°F - 180°F (0.6°C - 82.2°C)
Service	Air and Water
Outlet pressure range	20-70 psi <sup>1</sup>
Factory Set	45 psi

Materials		
1	Body	Lead-Free <sup>2</sup> Brass
2	Spring Chamber	1/2" and 3/4"
		Gray Iron
3	Adjustment Spring	1" - 2"
		Cast Aluminum
4	Body Seat	Steel (Zinc Plated)
5	Diaphragm	Stainless Steel
6	Seat Disc	Nylon Fabric Reinforced EPDM
7	Seat Disc	Buna-N
8	Piston	Lead-Free Bismuth Bronze
9	Piston Spring <sup>3</sup>	Stainless Steel
10	Strainer Screen	Stainless Steel/Monel

<sup>1</sup>Low (10-40 psi) and High (71-150 psi) pressure ranges are also available  
<sup>2</sup>Lead Free for all models. Surfaces that are in contact with consumable water contain less than 0.25% lead by weight.  
<sup>3</sup>Low pressure range only

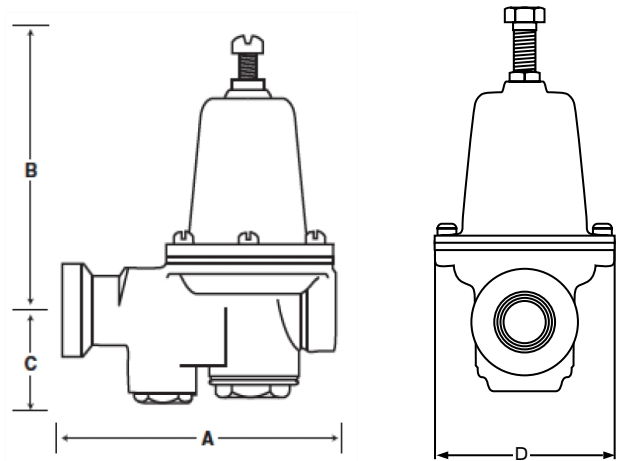

Dimensions (inches)				
Size	A	B	C	D
1/2"	5	5-1/4	1-3/4	3-1/8
3/4"	5-1/2	5-15/16	1-7/8	3-57/64
1"	6-7/16	7	2-11/16	4-3/4
1-1/4"	7-5/8	7-1/2	3	15-1/4
1-1/2"	8-7/8	8-1/2	3-1/4	5-3/4
2"	10-7/16	10-1/4	3-3/16	6-1/2

## Cash Acme PRV Cavitation Chart

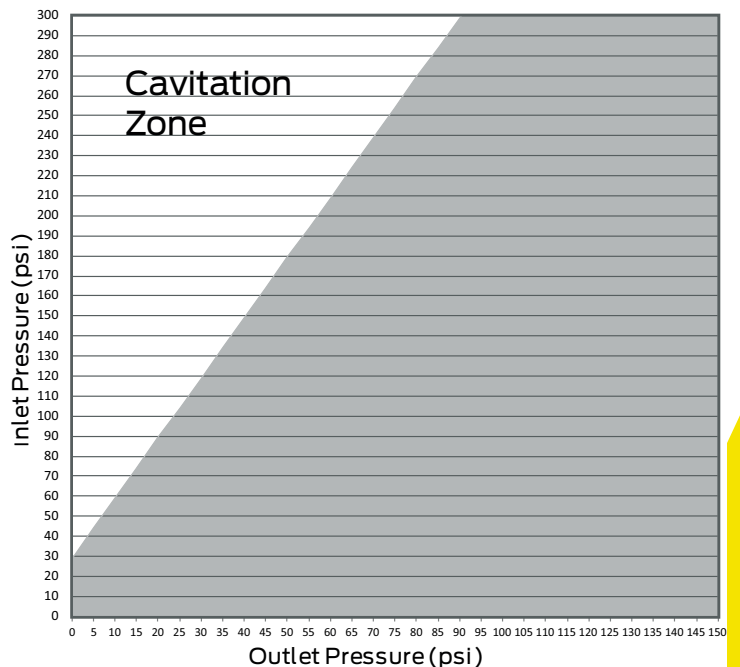

# Cash Acme E3 Water Capacity

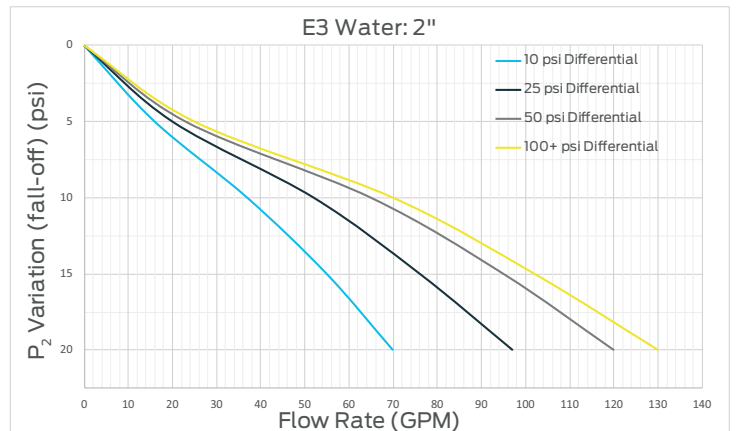
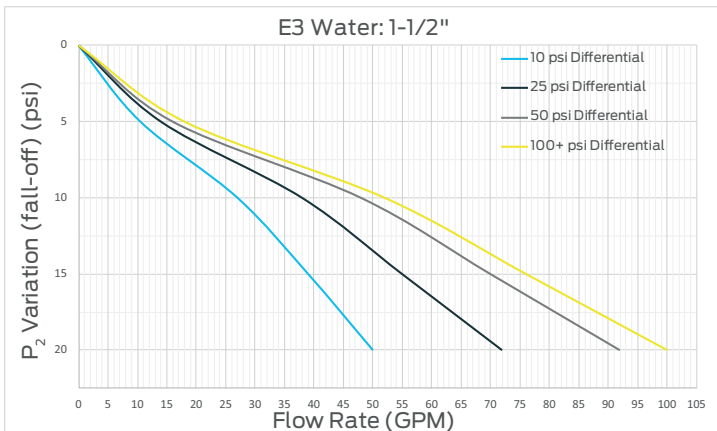
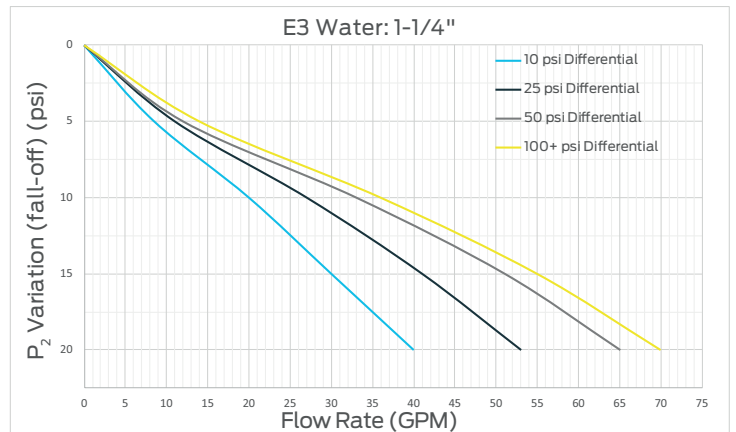
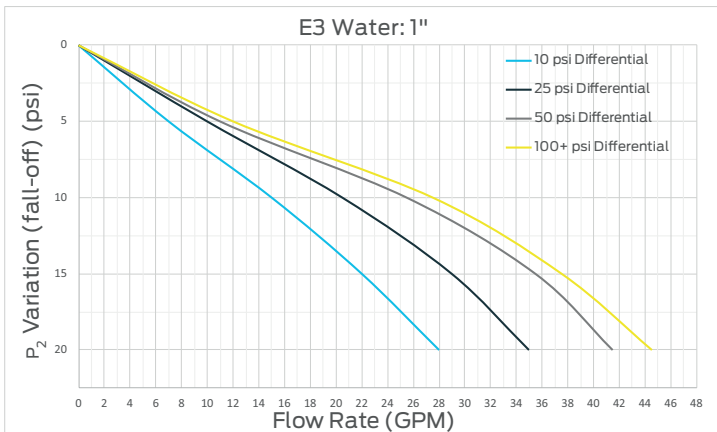
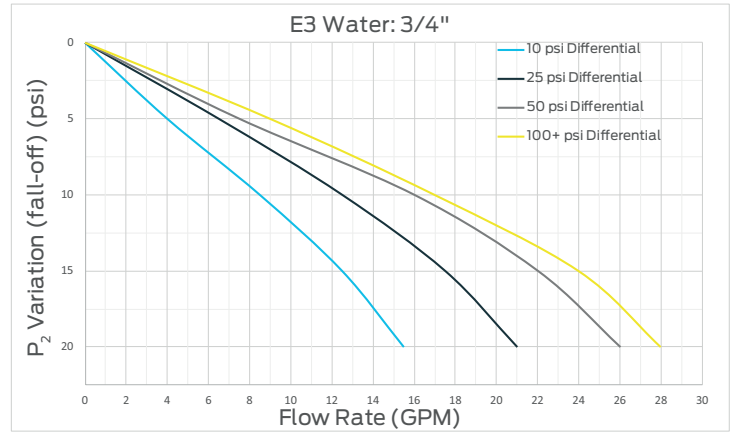
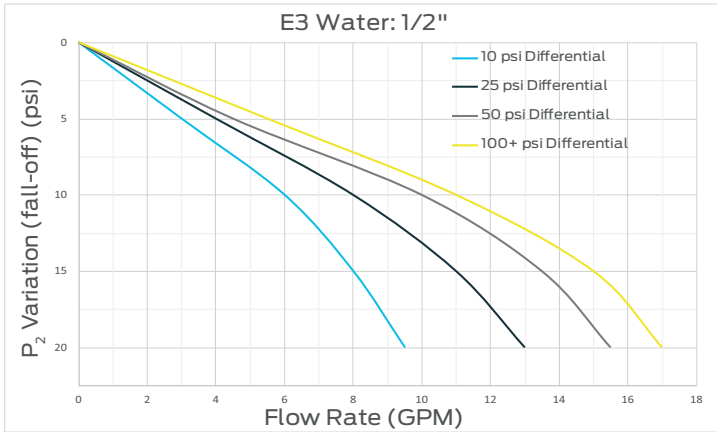

## Cash Acme E3 Air Capacity

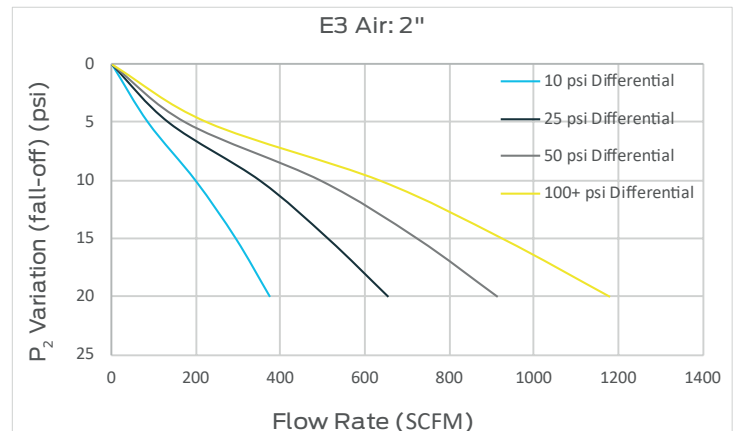
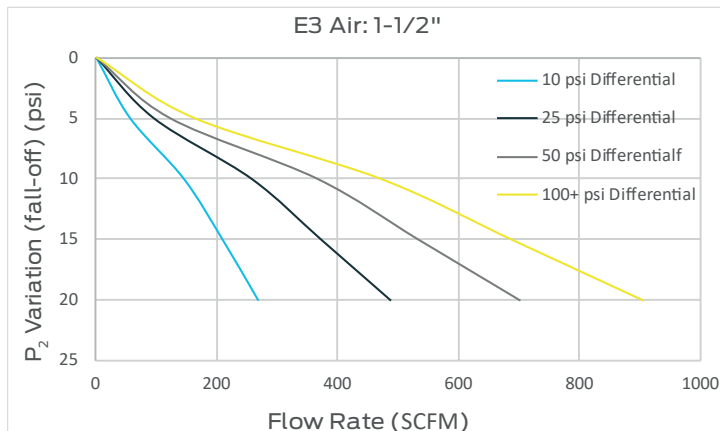
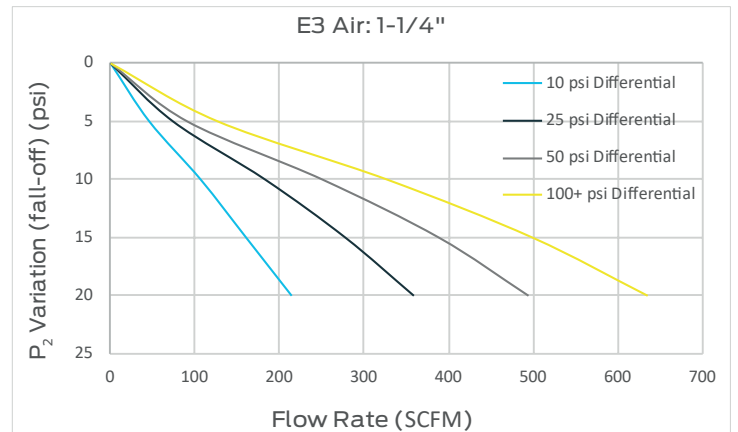
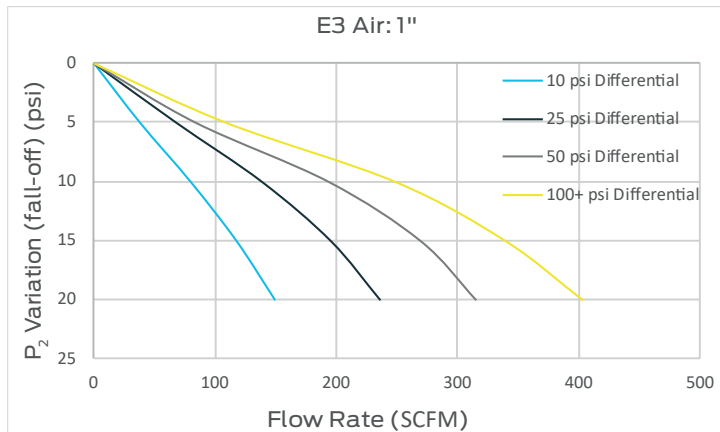
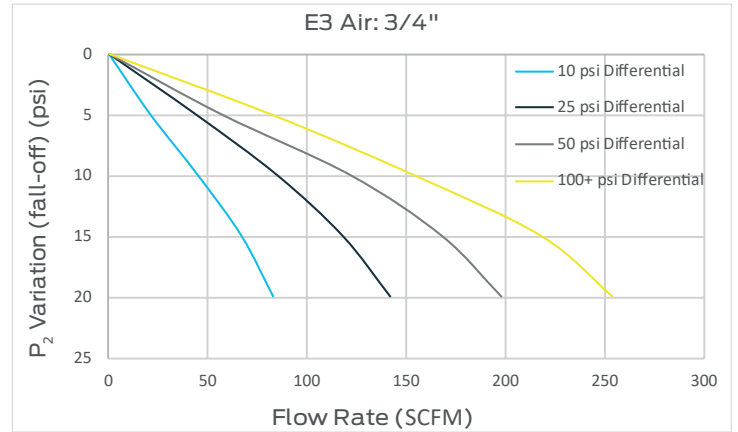
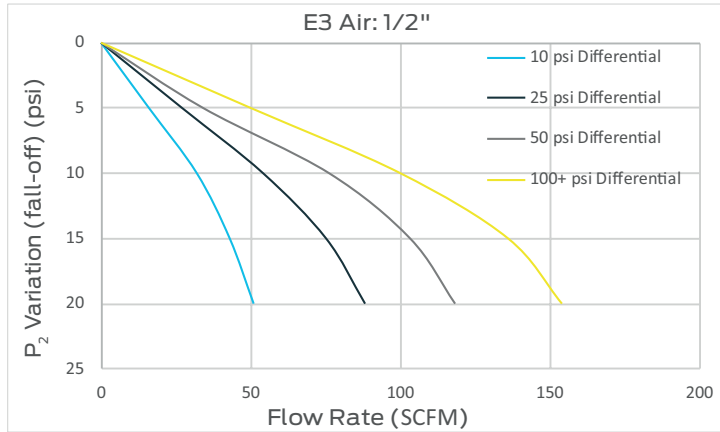

**Pressure Differential:** Difference between the inlet pressure and the PRV set pressure.

**P<sub>2</sub> Variation:** Pressure reduction of the outlet due to the demand created downstream when a fixture is opened and water is allowed to flow through the PRV.

### Certifications & Listings

ASSE 1003, NSF/ANSI 372

### Code approvals



Refer to local plumbing code

US 1 877 700 4242 | sales@cashacme.com | cashacme.com  
 Canada 1 888 820 0120 | canadales@rwc.com | cashacme.ca

This information is proprietary to RWC and is subject to change without notice. It may not be reproduced in part or whole without written authorization.

### Product Submittal

Name	
Date	
Architect/Owner	
Contractor	
Tag	
Notes	

Rev 1.0 / 12-08-21  
 Page 3 of 3 EN-US

